



(12) **United States Design Patent**
Ramos

(10) **Patent No.:** **US D828,082 S**
(45) **Date of Patent:** **** Sep. 11, 2018**

- (54) **COCONUT PIERCING DEVICE**
- (71) Applicant: **Andrew Ramos**, Hoboken, NJ (US)
- (72) Inventor: **Andrew Ramos**, Hoboken, NJ (US)
- (**) Term: **15 Years**
- (21) Appl. No.: **29/597,209**
- (22) Filed: **Mar. 15, 2017**
- (51) **LOC (11) Cl.** **31-00**
- (52) **U.S. Cl.**
USPC **D7/381**
- (58) **Field of Classification Search**
USPC D7/300.2, 372-385, 412-414, 693;
D1/102, 106; D21/642-664, 694; D8/45,
D8/107, 303; D28/9; D12/178; D23/9;
D26/9; 15/236.01
CPC A47J 43/0711; A47J 19/04; A47J 19/022;
A63B 65/122; A63B 60/38; B01L 3/18
See application file for complete search history.

D607,690 S * 1/2010 Bodum D7/376
8,234,974 B2 * 8/2012 Hanlon A47J 19/04
241/2
D708,726 S * 7/2014 Gordon D23/356
D777,985 S * 1/2017 Schlatter D28/85
D804,770 S * 12/2017 Zoubovsky D1/106
2014/0352127 A1 * 12/2014 Dakis A47J 31/4407
29/428

OTHER PUBLICATIONS

Creative Hobbies wood posted Jan. 9, 2015,[online], [retirved Jul. 2, 2018]. Retrived from internet: https://www.amazon.com/Creative-Hobbies-Dipper-Dispense-Drizzle/product-reviews/B00127TVIA/ref=cm_cr_othr_d_paging_btm_17?ie=UTF8&reviewerType=all_reviews&sortBy=recent&pageNumber=17.*

“Honey Dipper 3D” posted 05/11/5/2017,[online], [retirved Jul. 2, 2018]. Retrived from internet: https://www.amazon.com/Creative-Hobbies-Dipper-Dispense-Drizzle/product-reviews/B00127TVIA/ref=cm_cr_othr_d_paging_btm_17?ie=UTF8&reviewerType=all_reviews&sortBy=recent&pageNumber=17.*

* cited by examiner

Primary Examiner — Barbara Fox
Assistant Examiner — Mehri F Bajoul
(74) *Attorney, Agent, or Firm* — Michael J. Feigin, Esq.;
Feigin and Fridman

(56) **References Cited**

U.S. PATENT DOCUMENTS

- D32,120 S * 1/1900 Estes D9/600
- 1,161,811 A 11/1915 Horn et al.
- 1,402,234 A 1/1922 Jones
- D149,511 S * 5/1948 Mitzel D1/102
- 2,637,537 A * 5/1953 Arthur A47J 43/0711
366/317
- 2,666,465 A 1/1954 Beeken
- 2,782,825 A 1/1954 Rey
- D186,902 S * 12/1959 Fried D7/683
- 3,411,723 A * 11/1968 Kohn A61C 19/00
15/236.01
- 4,452,289 A 6/1984 Smith
- 5,201,460 A 4/1993 Caines
- D346,090 S * 4/1994 Sham D7/381
- D364,451 S * 11/1995 Rosenschein D23/366
- 5,613,413 A 3/1997 Huang
- D421,872 S * 3/2000 Wong D7/376
- D546,907 S * 7/2007 Dykgraaf D21/662
- 7,514,618 B2 * 4/2009 Calato G10D 13/003
84/422.1
- D600,091 S * 9/2009 Liu D8/107

(57) **CLAIM**

The ornamental design for a coconut piercing, as shown and described.

DESCRIPTION

FIG. 1 is a top side perspective view of a coconut piercing device showing the new design;
FIG. 2 is a bottom and side perspective view thereof.
FIG. 3 is a first elevation view thereof.
FIG. 4 is a second elevation view thereof.
FIG. 5 is a top plan view thereof; and,
FIG. 6 is a bottom plan view thereof.

1 Claim, 3 Drawing Sheets

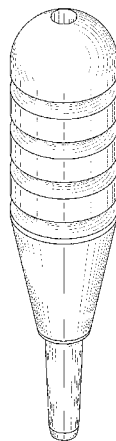

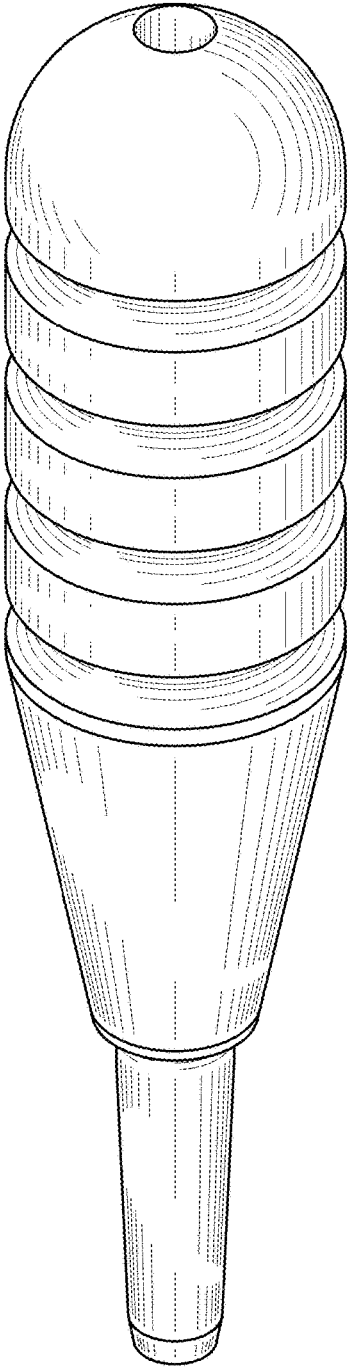

FIG. 1

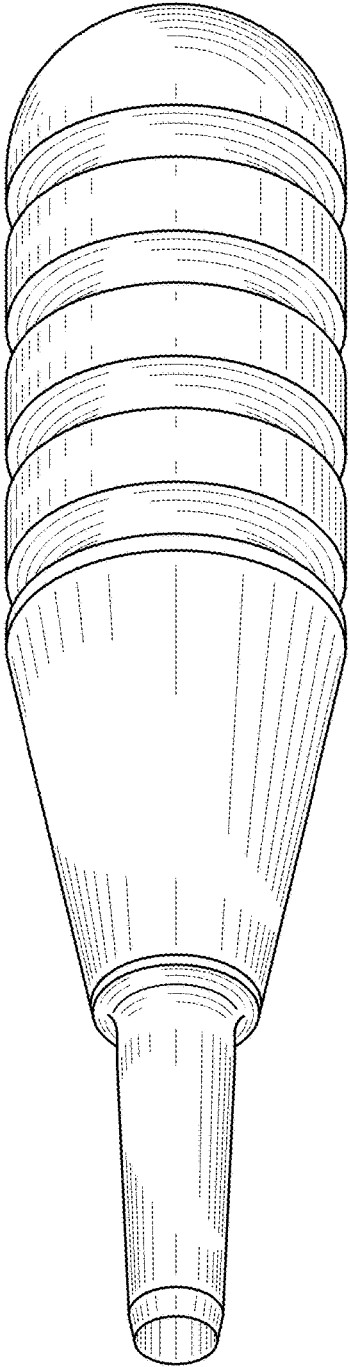

FIG. 2

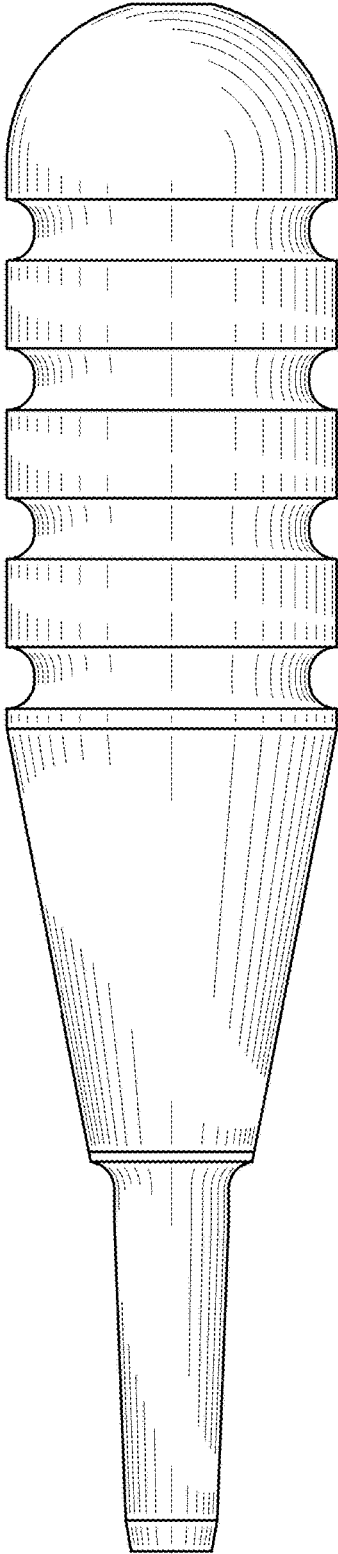

FIG. 3

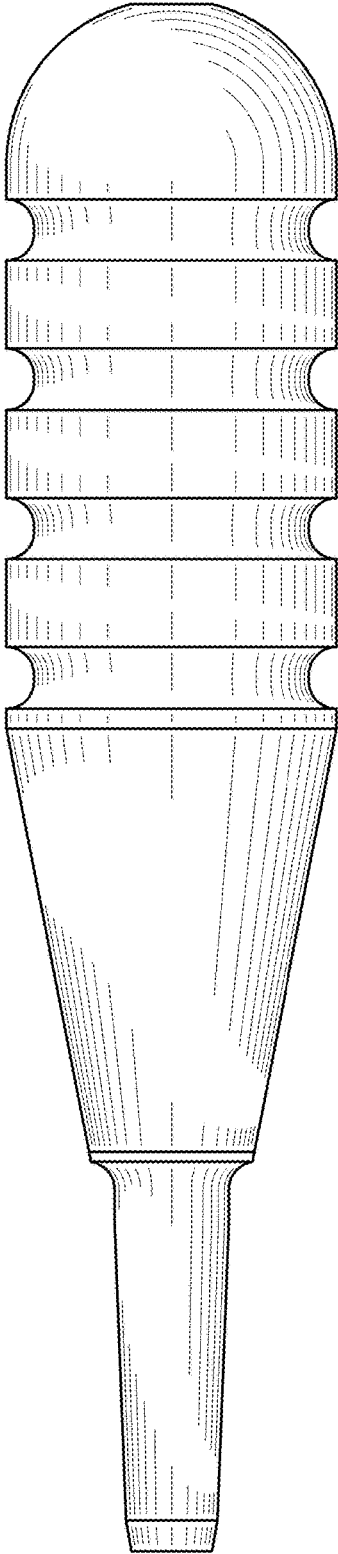

FIG. 4

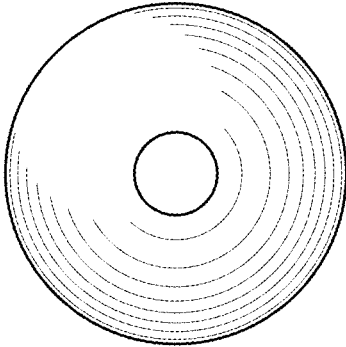

FIG. 5

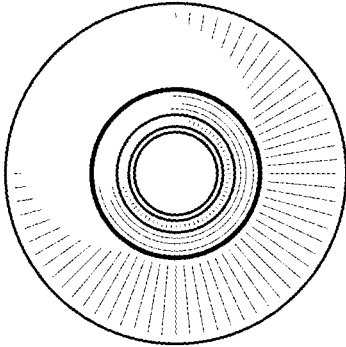

FIG. 6