



US00D860682S

(12) **United States Design Patent** (10) **Patent No.:** **US D860,682 S**  
**Gaetano** (45) **Date of Patent:** **\*\* Sep. 24, 2019**

(54) **ROLL-UP WINDOW COVER WITH HOOK AND LOOP FASTENERS**

5,996,674 A \* 12/1999 Gatewood ..... A47H 13/14  
160/113  
7,805,897 B2 \* 10/2010 Holland ..... E06B 9/02  
160/108  
D637,853 S \* 5/2011 Ehram ..... D6/575  
D728,264 S \* 5/2015 Bacolas  
D735,073 S \* 7/2015 Skinner ..... D11/165  
9,345,357 B1 \* 5/2016 Davila, Jr. .... A47H 1/00  
D789,244 S \* 6/2017 Skinner ..... D11/165  
D789,246 S \* 6/2017 Skinner ..... D11/165  
D798,767 S \* 10/2017 Skinner ..... D11/165

(71) Applicant: **Achille Gaetano**, North Bergen, NJ (US)

(72) Inventor: **Achille Gaetano**, North Bergen, NJ (US)

(\*\*) Term: **15 Years**

(21) Appl. No.: **29/647,549**

(22) Filed: **May 14, 2018**

(51) **LOC (12) Cl.** ..... **06-10**

(52) **U.S. Cl.** ..... **D6/575**  
USPC .....

(58) **Field of Classification Search**  
USPC ..... D6/575-581; D8/358; D13/155;  
D25/119, 121, 123, 125; D26/138  
CPC : A47H 1/02; A47H 1/04; A47H 1/144; A47H  
11/06; A47H 2001/042; A47H 2023/003;  
A47H 2023/025; A47H 23/00; A47H  
23/01; A47H 23/02; A47H 3/02; A47H  
3/06; A47H 3/08; A47H 3/10; A47H  
5/00; A47H 5/03; A47H 5/032; A47H  
5/06; A47H 5/08; E06B 2009/2622; E06B  
2009/285; E06B 9/26; E06B 9/262; E06B  
9/30; E06B 9/302; E06B 9/306; E06B  
9/307; E06B 9/322; E06B 9/323; E06B  
9/324; E06B 9/386; E06B 9/388; E06B  
9/40; E06B 9/42; E06B 9/521; E06B  
9/56; E06B 9/60; E06B 9/78

See application file for complete search history.

(56) **References Cited**

**U.S. PATENT DOCUMENTS**

1,615,931 A \* 2/1927 Cann ..... F01P 7/10  
160/239  
4,372,364 A \* 2/1983 Katz ..... E06B 7/28  
150/154  
5,193,602 A \* 3/1993 Morales ..... B60P 3/343  
160/243

(Continued)

**OTHER PUBLICATIONS**

“ALP Lockdown Shades—Most Secure Classroom Blackout Shade”  
by ALP Sewing. Accessed on Jun. 6, 2019 (Year: 2019).\*

(Continued)

*Primary Examiner* — Kevin K Rudzinski  
*Assistant Examiner* — Clare Ann Gannon  
(74) *Attorney, Agent, or Firm* — Michael J. Feigin, Esq.;  
Feigin and Fridman LLC

(57) **CLAIM**

The ornamental design for a roll-up window cover with hook and loop fasteners, as shown and described.

**DESCRIPTION**

FIG. 1 shows a front and side perspective view of a roll-up window cover with hook and loop fasteners.  
FIG. 2 shows a front elevation view thereof.  
FIG. 3 shows a rear elevation view thereof.  
FIG. 4 shows a right side view thereof.  
FIG. 5 shows a left side view thereof.  
FIG. 6 shows a top plan view thereof.  
FIG. 7 shows a bottom plan view thereof; and,  
FIG. 8 shows a top and side perspective view of the window cover in a rolled-up configuration.  
The broken lines in the drawings represents stitching, which form a part of the claim.

**1 Claim, 5 Drawing Sheets**

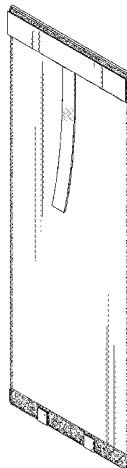

(56)

**References Cited**

U.S. PATENT DOCUMENTS

2005/0092448	A1	5/2005	Lin	
2006/0115620	A1*	6/2006	Anderson	..... A47H 23/04 428/99
2007/0062136	A1*	3/2007	Kim	..... E06B 3/7001 52/311.2
2010/0155001	A1*	6/2010	Bolton	..... E06B 7/28 160/368.1
2010/0212789	A1*	8/2010	De La Croix	..... A47H 99/00 150/154
2010/0263808	A1	10/2010	Hanley et al.	
2010/0326485	A1*	12/2010	Li	..... E04H 15/16 135/122
2014/0251559	A1*	9/2014	Loper	..... E06B 9/42 160/323.1
2014/0352899	A1*	12/2014	Moolenbeek	..... E06B 9/40 160/368.1
2015/0259973	A1*	9/2015	Beaudoin	..... E06B 9/04 49/394
2016/0362933	A1*	12/2016	Mueller	..... E06B 9/00
2019/0100959	A1*	4/2019	Chang	..... E06B 9/262

OTHER PUBLICATIONS

“Guardian Lockdown Window Shade” by Guardian. Sold by School Specialty. . Accessed on Jun. 6, 2019 (Year: 2019).\*

“How To Install The Hideaway Helper”. By School Safety Solutions LLC. Vimeo video. . Accessed on Jun. 6, 2019 (Year: 2019).\*

Media Tweets by School Safety Solution LLC (@HideawayHelper). Twitter.com. Multiple dates starting in Mar. 17, 2014. . Accessed on Jun. 6, 2019. (Year: 2014).\*

Lockdown Shades for Classroom Doors by GoldenThimble Designs. Etsy.com. . Accessed on Jun. 6, 2019 (Year: 2019).\*

Gallery—Threaded Needle by Brinda, Corporation. . Accessed on Jun. 6, 2019. (Year: 2019).\*

“10 Best Organizing Tips for the Classroom.” Rockin Resources. Aug. 10, 2014. . Accessed on Jun. 6, 2019. (Year: 2014).\*

Hook & Loop Tape [online]. Retrieved on Jul. 30, 2018 from the Internet. <URL: <https://web.archive.org/web/20130101211538/http://www.blackoutez.com:80/Hook-Loop-Tape-For-Blackout-EZ-Window-Covers/>>.

Choose Your Window Size—TempShield For Schools [online]. Retrieved on Jul. 30, 2018 from the Internet: <URL: <http://tempshieldschools.com:80/choose-your-window-size/>>.

Custom Blackout EZ WindowCover [online]. Retrieved on Jul. 30, 2018 from the Internet: <URL: <https://web.archive.org/web/20130101212022/http://www.blackoutez.com/Custom-Sizes/Custom-Blackout-EZ-Window-Cover/>>.

Citizen Scientist, Roman Shades For Classroom Windows [online]. Retrieved on Jul. 30, 2018 from the Internet: <URL: <https://www.instructables.com/id/Roman-Shades-for-Classroom-Windows/>>.

Velcro Option—TempShield for Schools [online]. Retrieved on Jul. 30, 2018 from the Internet: <URL: <http://tempshieldschools.com:80/velcro-mounting/>>.

\* cited by examiner

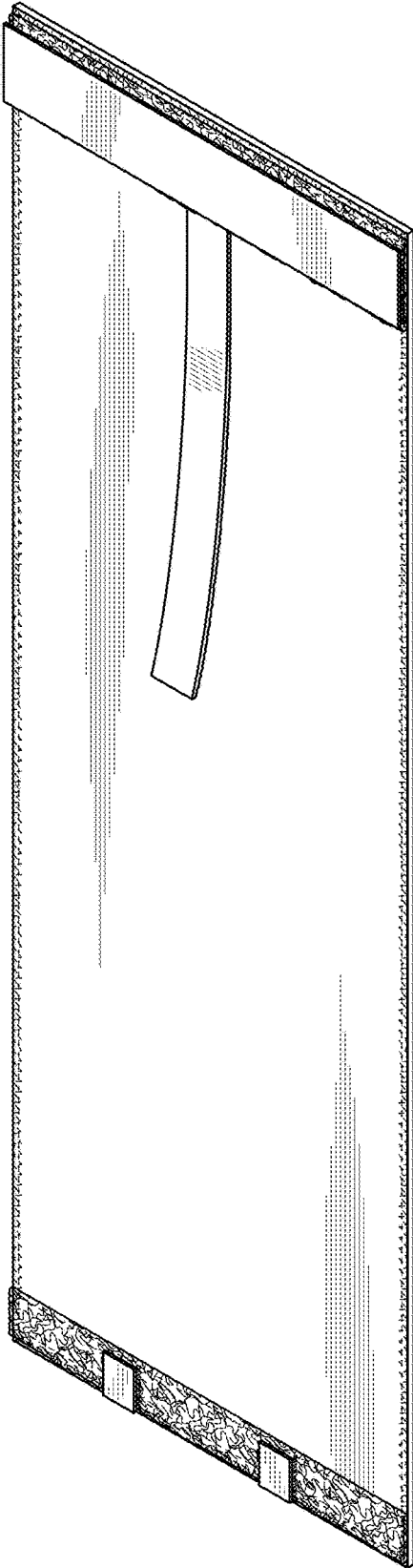

FIG. 1

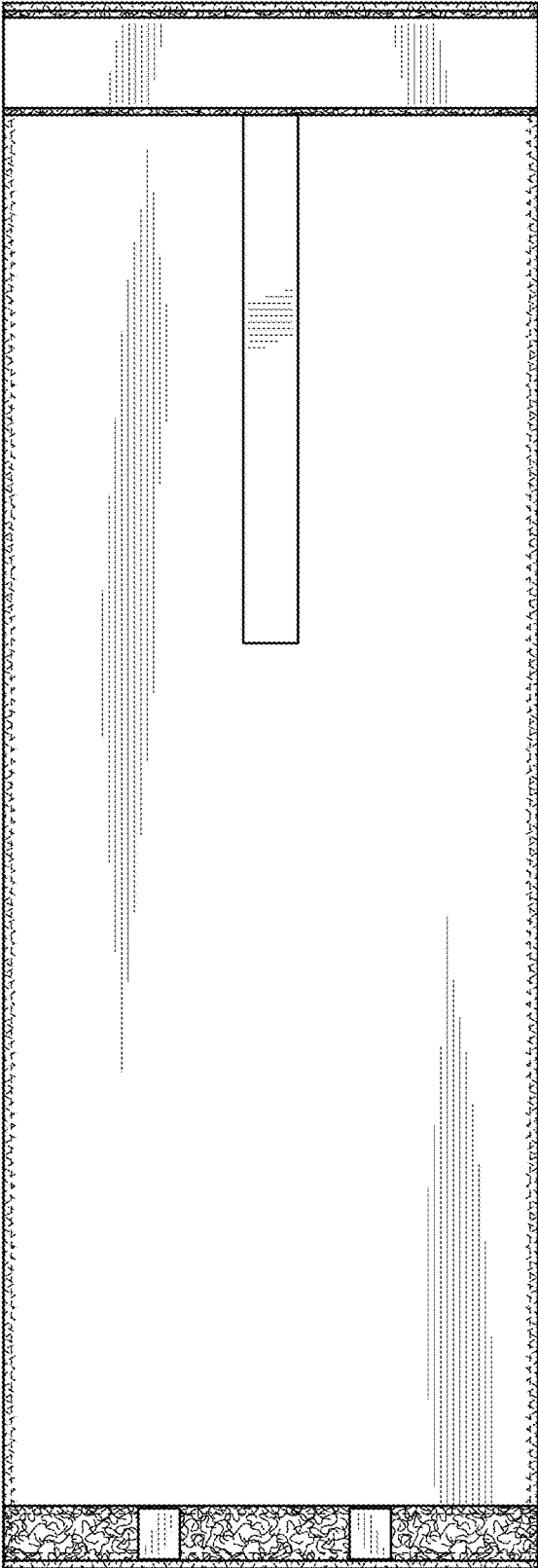

FIG. 2

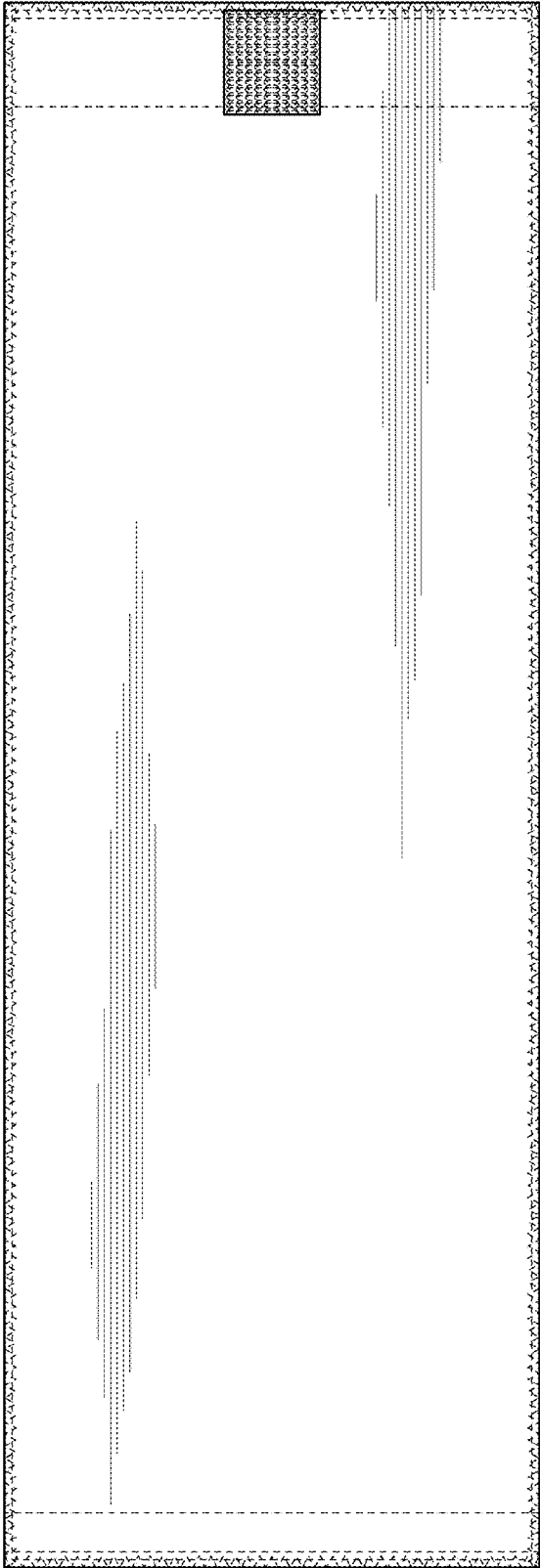

FIG. 3

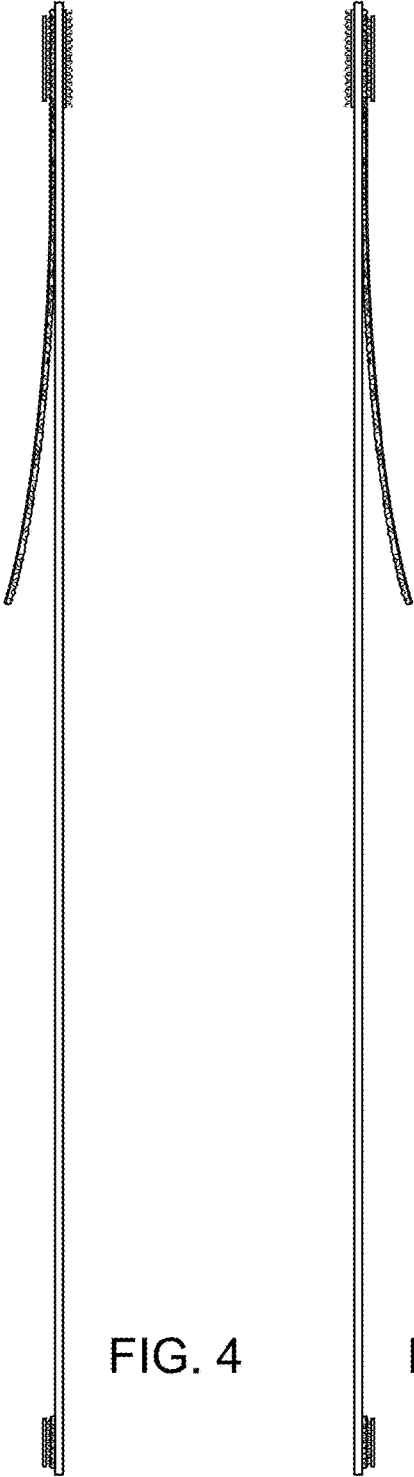

FIG. 4

FIG. 5

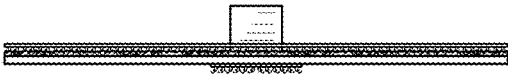

FIG. 6

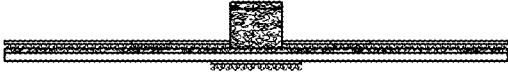

FIG. 7

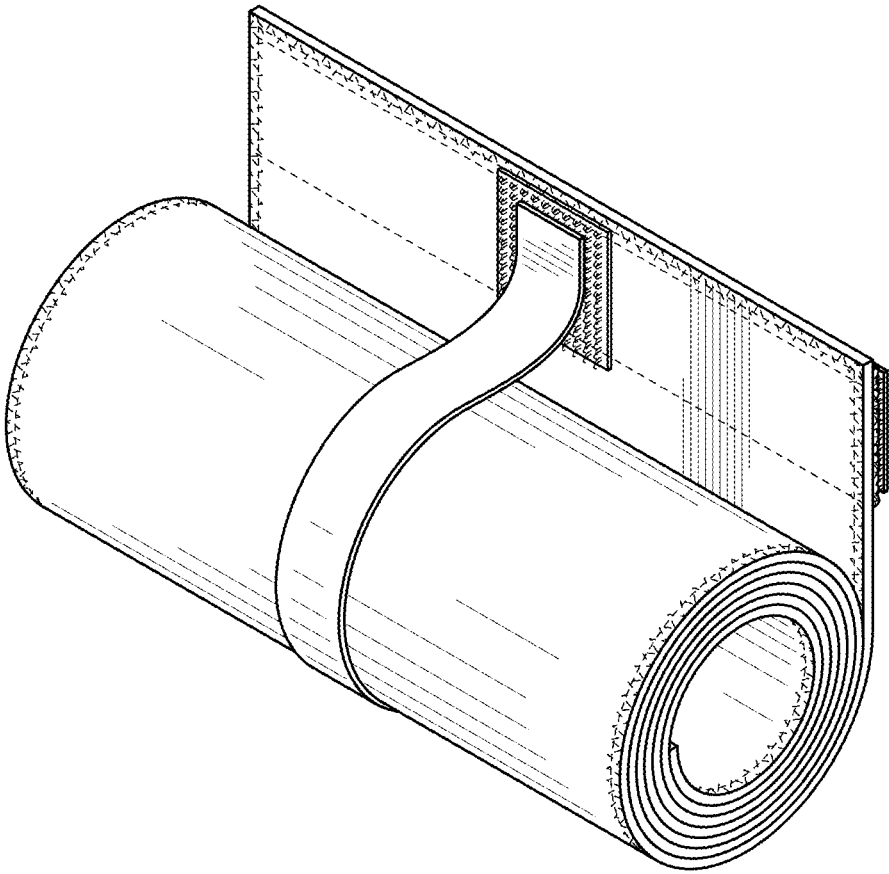

FIG. 8