



US00D874640S

(12) **United States Design Patent**
Aboff

(10) **Patent No.:** **US D874,640 S**

(45) **Date of Patent:** **** Feb. 4, 2020**

(54) **COLUMELLA NASAL CLIP DILATOR**

2013/0150658 A1* 6/2013 Miledi A61M 21/02
600/27
2018/0064892 A1* 3/2018 Nelson A61M 15/08
2019/0054263 A1* 2/2019 Aboff A61L 9/012

(71) Applicant: **Clifford S. Aboff**, Brooklyn, NY (US)

(72) Inventor: **Clifford S. Aboff**, Brooklyn, NY (US)

* cited by examiner

(**) Term: **15 Years**

Primary Examiner — Richelle G Shelton

(21) Appl. No.: **29/667,450**

(74) *Attorney, Agent, or Firm* — Michael J. Feigin; Feigin and Fridman LLC

(22) Filed: **Oct. 22, 2018**

(57) **CLAIM**

(51) **LOC (12) Cl.** **24-04**

The ornamental design for a columella nasal clip dilator, as shown and described.

(52) **U.S. Cl.**

USPC **D24/106**

(58) **Field of Classification Search**

USPC D24/106, 135, 164, 187, 200
CPC A62B 9/06; A61F 5/08; A61F 5/56; A61H
39/04; A61M 29/00

See application file for complete search history.

DESCRIPTION

FIG. 1 shows a bottom side perspective view of the columella nasal clip dilator.

FIG. 2 shows a front elevation view thereof.

FIG. 3 shows a rear elevation view thereof.

FIG. 4 shows a side view thereof, the opposite side being a mirror image.

FIG. 5 shows a top plan view thereof; and,

FIG. 6 shows a bottom plan view thereof.

(56) **References Cited**

U.S. PATENT DOCUMENTS

D623,306 S * 9/2010 Boyer D24/106
D739,519 S * 9/2015 Davi D24/106

1 Claim, 5 Drawing Sheets

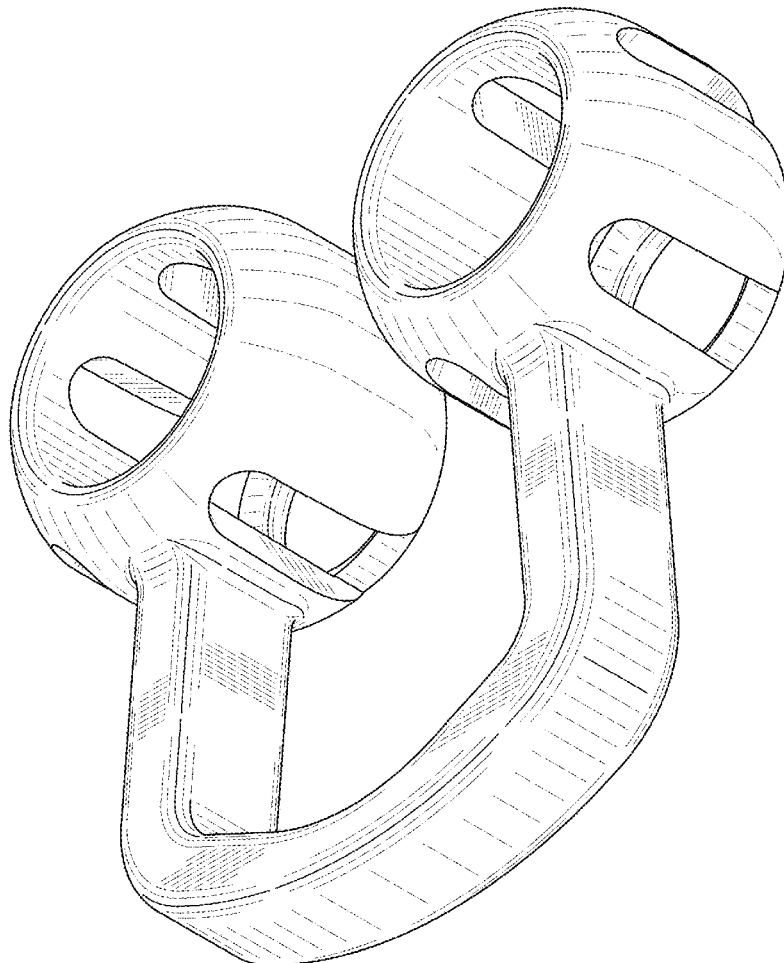

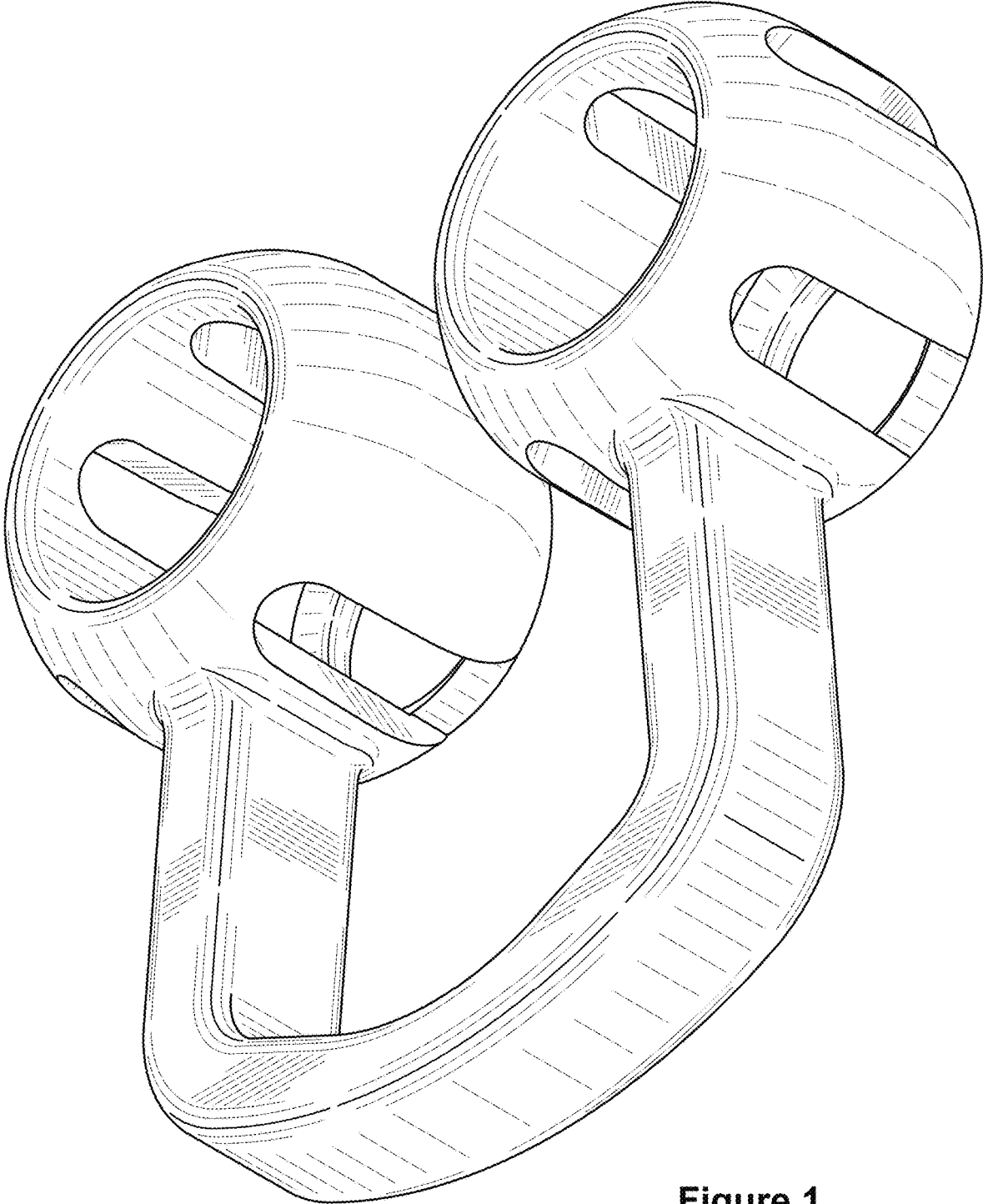

Figure 1

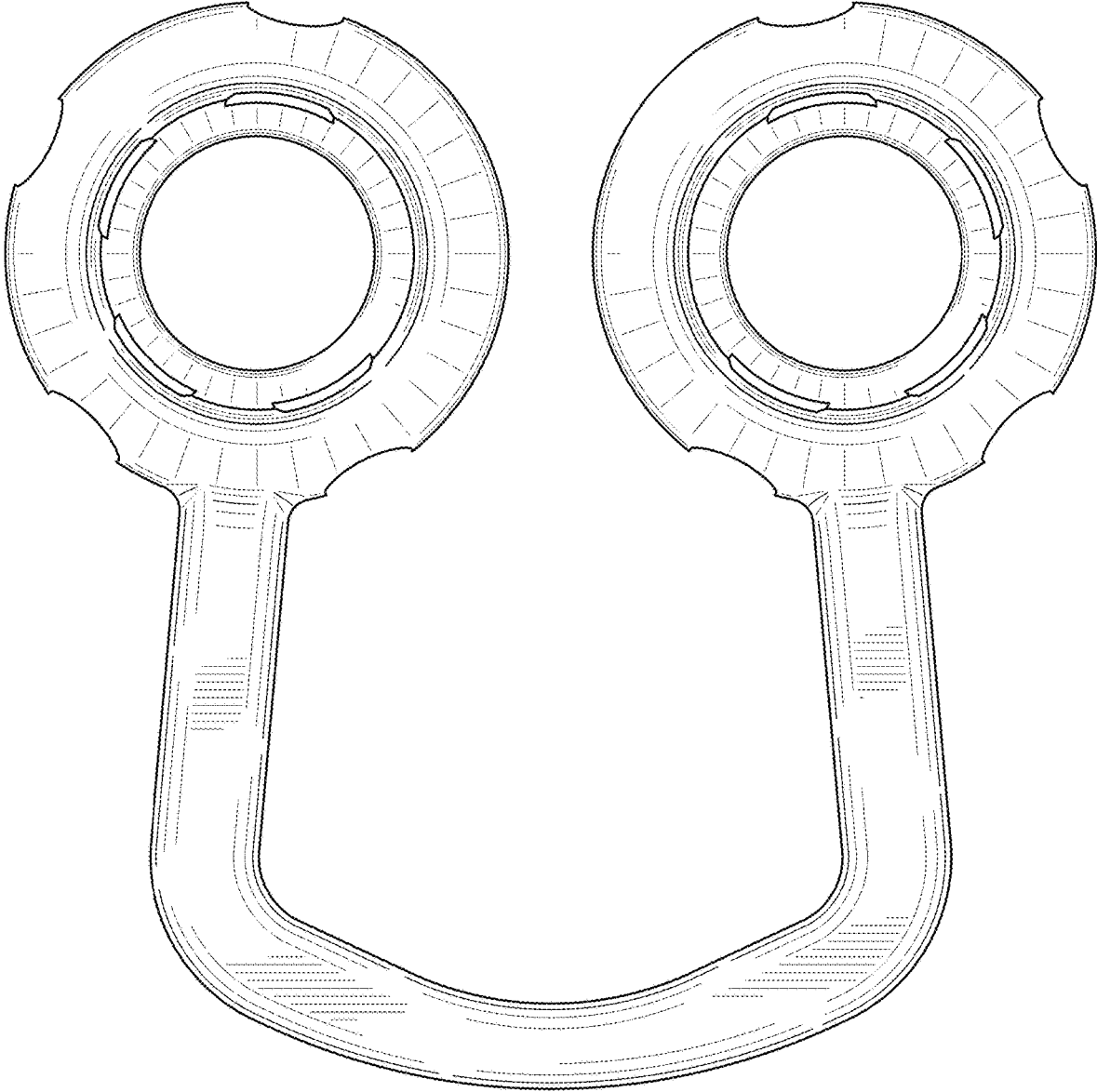

Figure 2

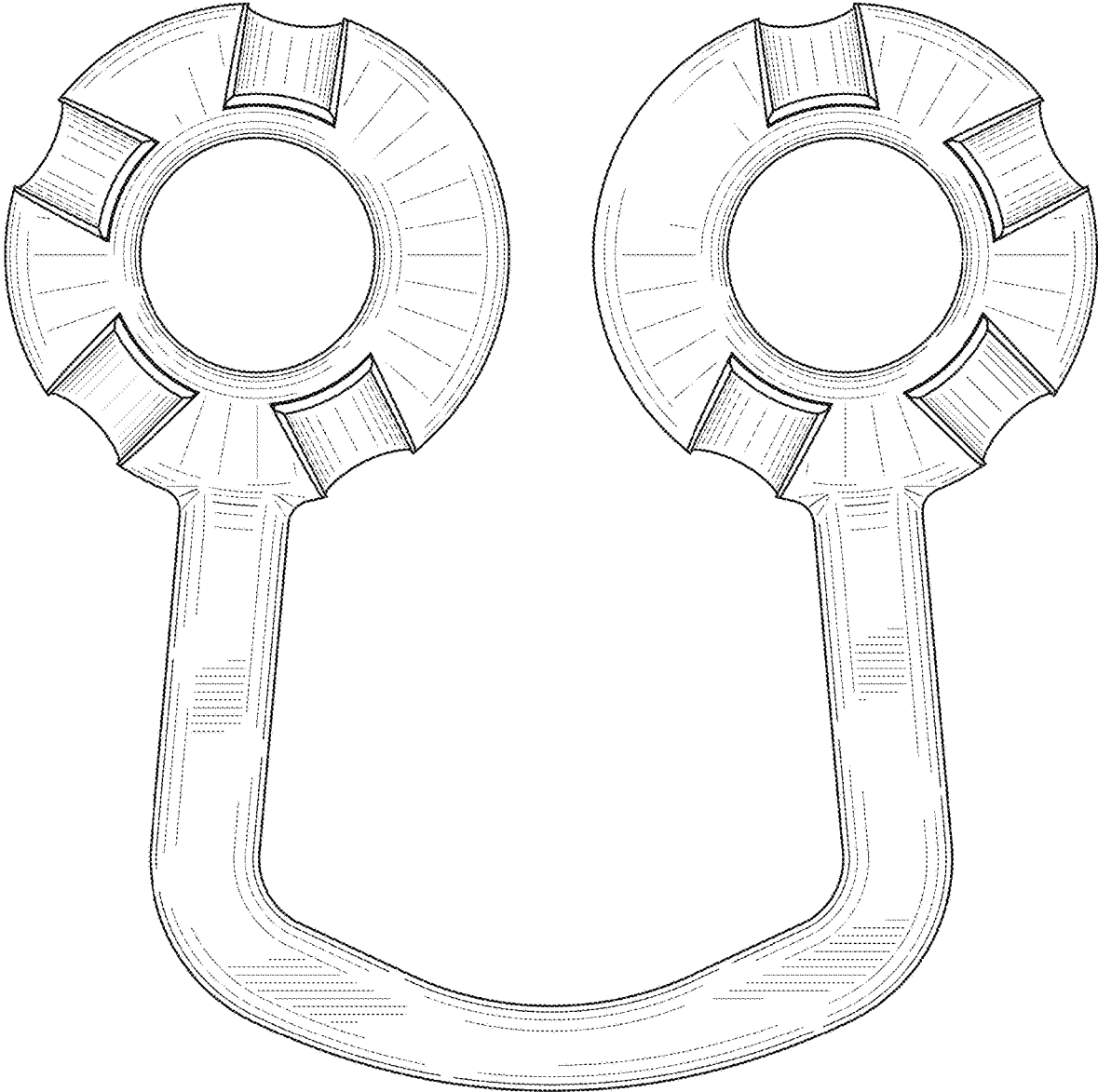

Figure 3

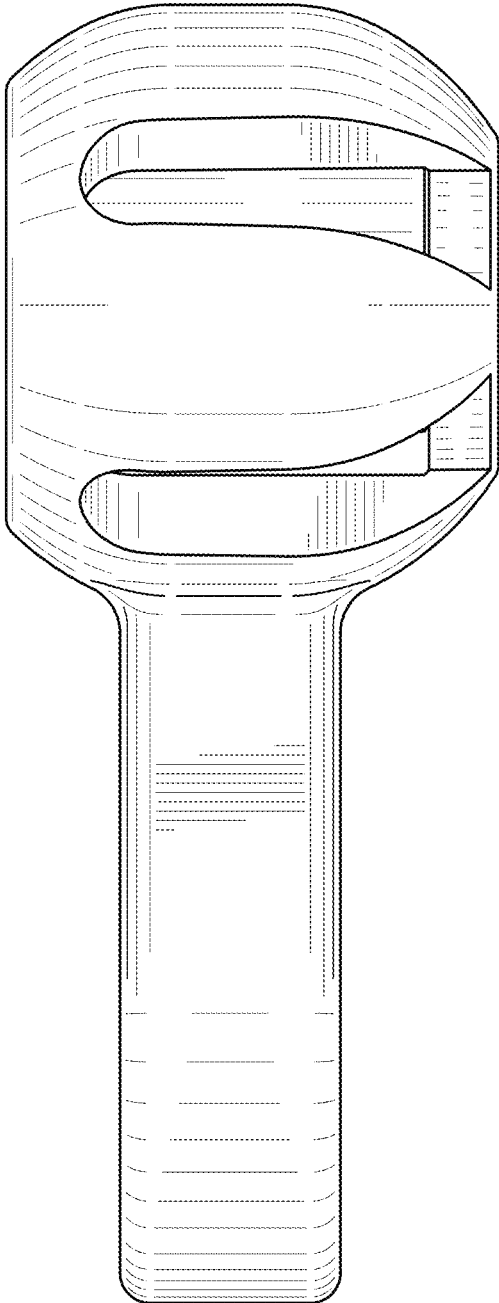

Figure 4

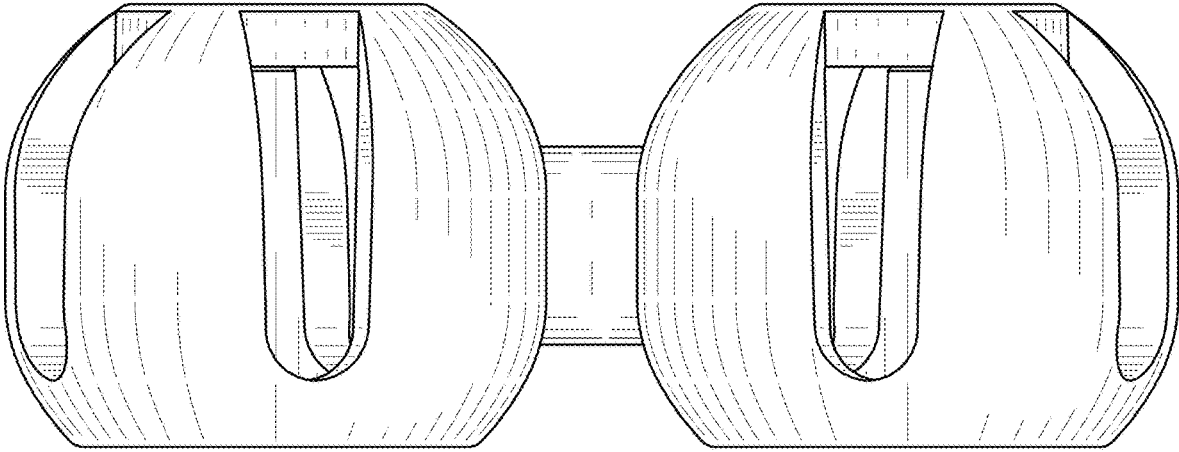

Figure 5

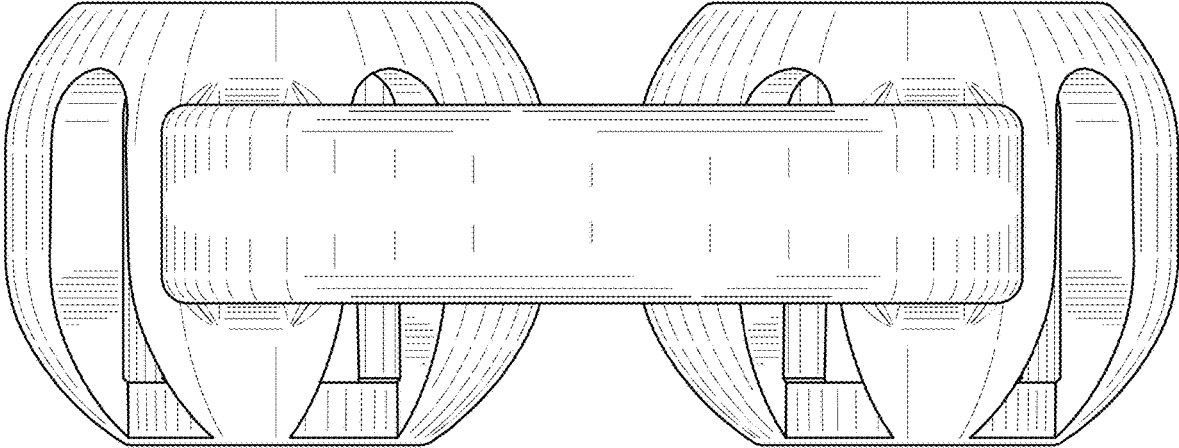

Figure 6