



US00D891191S

(12) **United States Design Patent**  
**Binyk**

(10) **Patent No.:** **US D891,191 S**

(45) **Date of Patent:** **\*\* Jul. 28, 2020**

(54) **FOOD CONTAINER**  
(71) Applicant: **Anastasiia Binyk**, Brovary (UA)  
(72) Inventor: **Anastasiia Binyk**, Brovary (UA)

D740,076 S 10/2015 Hwang  
D741,169 S \* 10/2015 Lutz ..... D9/429  
D741,708 S 10/2015 Thurin et al.  
D791,586 S 7/2017 Bois  
D821,159 S \* 6/2018 Wahl ..... D7/629  
D823,683 S \* 7/2018 Caldwell ..... D9/435

(\*\*) Term: **15 Years**

\* cited by examiner

(21) Appl. No.: **29/688,463**

*Primary Examiner* — Susan E Krakower

*Assistant Examiner* — Andrew Kerr

(22) Filed: **Apr. 22, 2019**

(74) *Attorney, Agent, or Firm* — Lawrence G. Fridman,  
Esq.; Feigin & Fridman, LLC

(51) **LOC (12) Cl.** ..... **07-07**

(52) **U.S. Cl.**  
USPC ..... **D7/602**

(57) **CLAIM**

The ornamental design for a food container, as shown and described.

(58) **Field of Classification Search**  
USPC ..... D7/602, 605, 612, 615, 629, 630;  
D9/549, 737, 738, 761, 516  
CPC .... B65D 21/00; B65D 21/02; B65D 21/0212;  
B65D 21/0209; B65D 13/00; B65D  
43/00; B65D 43/02

**DESCRIPTION**

FIG. 1 is a top perspective of a first embodiment a food container according to my new design;  
FIG. 2 is a bottom perspective view thereof;  
FIG. 3 is a side elevational view thereof;  
FIG. 4 is a rear elevational view thereof;  
FIG. 5 is a front elevational view thereof;  
FIG. 6 is a top plan view thereof;  
FIG. 7 is a bottom plan view thereof;  
FIG. 8 is a top perspective view of a second embodiment a food container according to my new design;  
FIG. 9 is bottom perspective view thereof;  
FIG. 10 is a side elevational view thereof;  
FIG. 11 is a rear elevational view thereof;  
FIG. 12 is a front elevational view thereof;  
FIG. 13 is a top plan view thereof; and,  
FIG. 14 is a bottom plan view thereof.

See application file for complete search history.

(56) **References Cited**

U.S. PATENT DOCUMENTS

3,552,548 A \* 1/1971 Wallestad ..... B65D 25/10  
206/710  
3,578,467 A \* 5/1971 Huber ..... B65D 39/02  
426/112  
4,027,776 A 6/1977 Douglas  
D367,589 S 3/1996 Zimmerman  
D415,652 S \* 10/1999 Loew ..... D7/392.1  
D419,394 S 1/2000 Wilson et al.  
D482,934 S \* 12/2003 Liu ..... D7/602  
D508,188 S 8/2005 Zettle et al.  
D518,336 S \* 4/2006 Hirani ..... D7/629  
D643,694 S \* 8/2011 Lu ..... D7/629

**1 Claim, 13 Drawing Sheets**

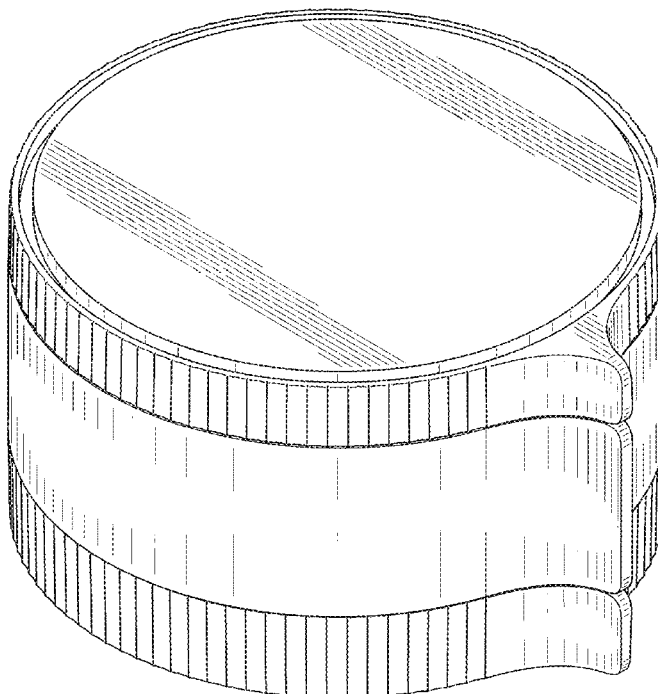

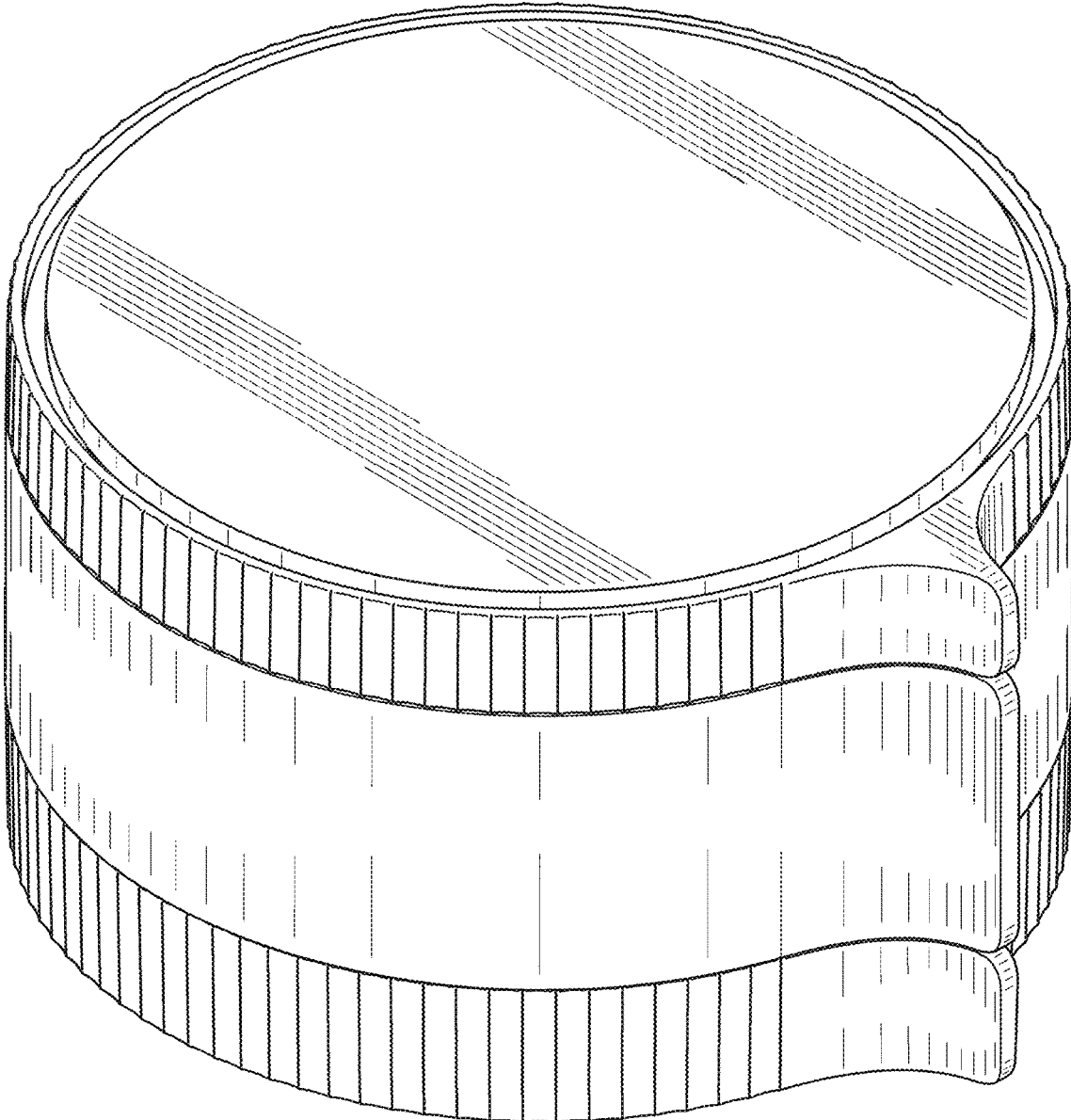

FIG. 1

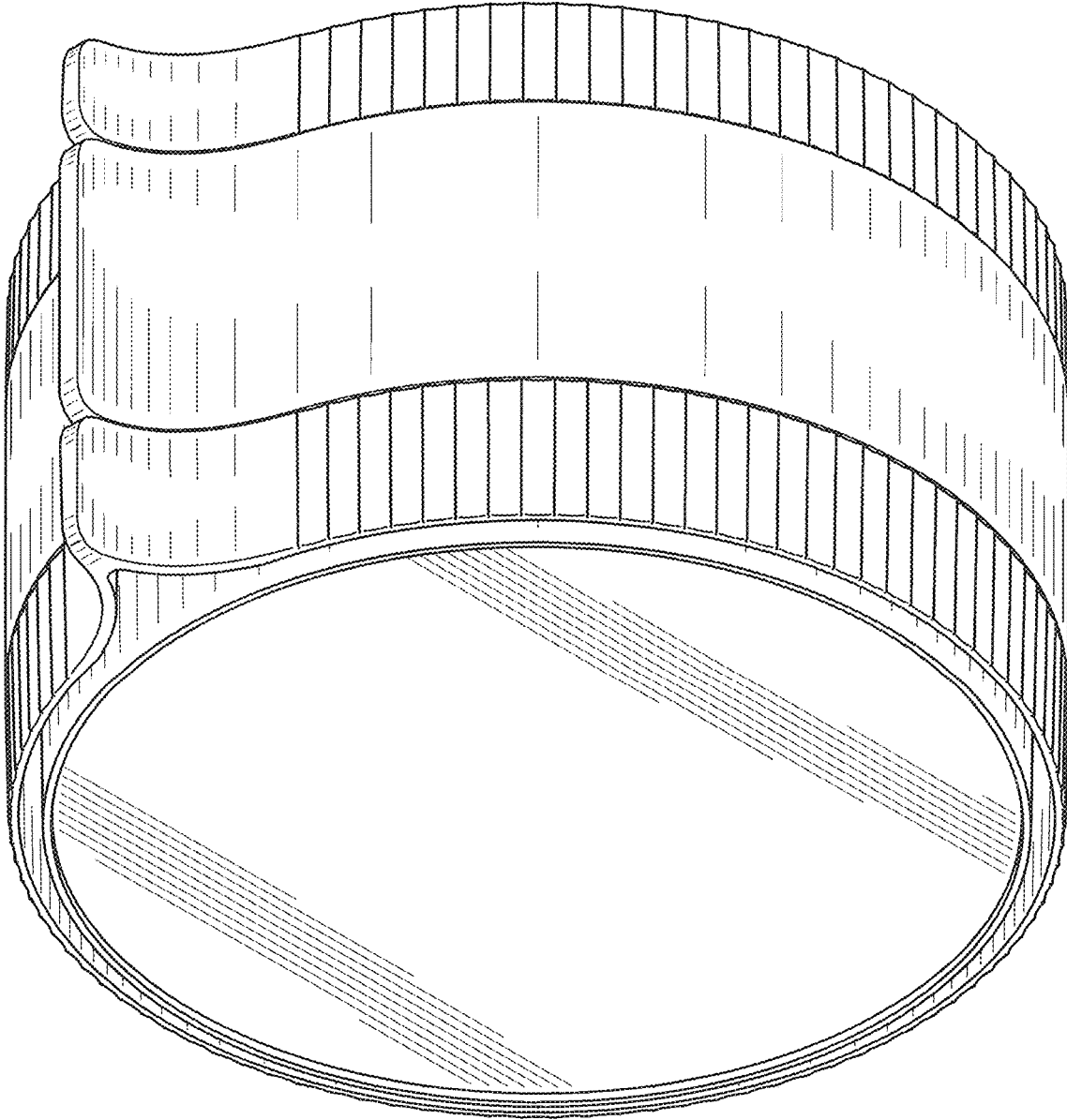

FIG. 2

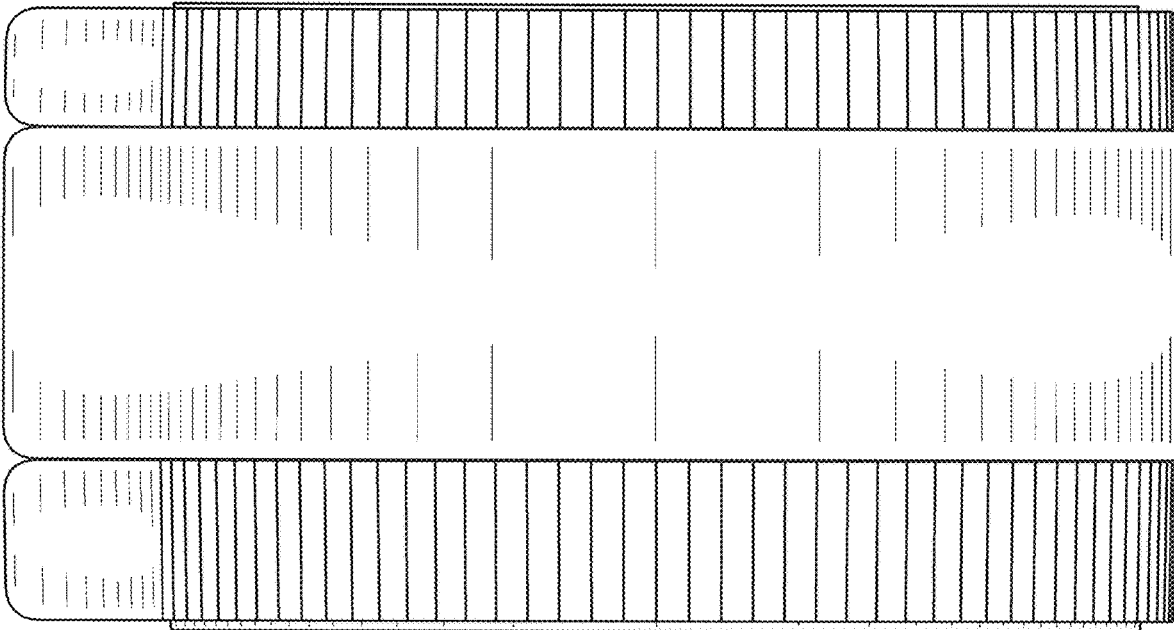

FIG. 3

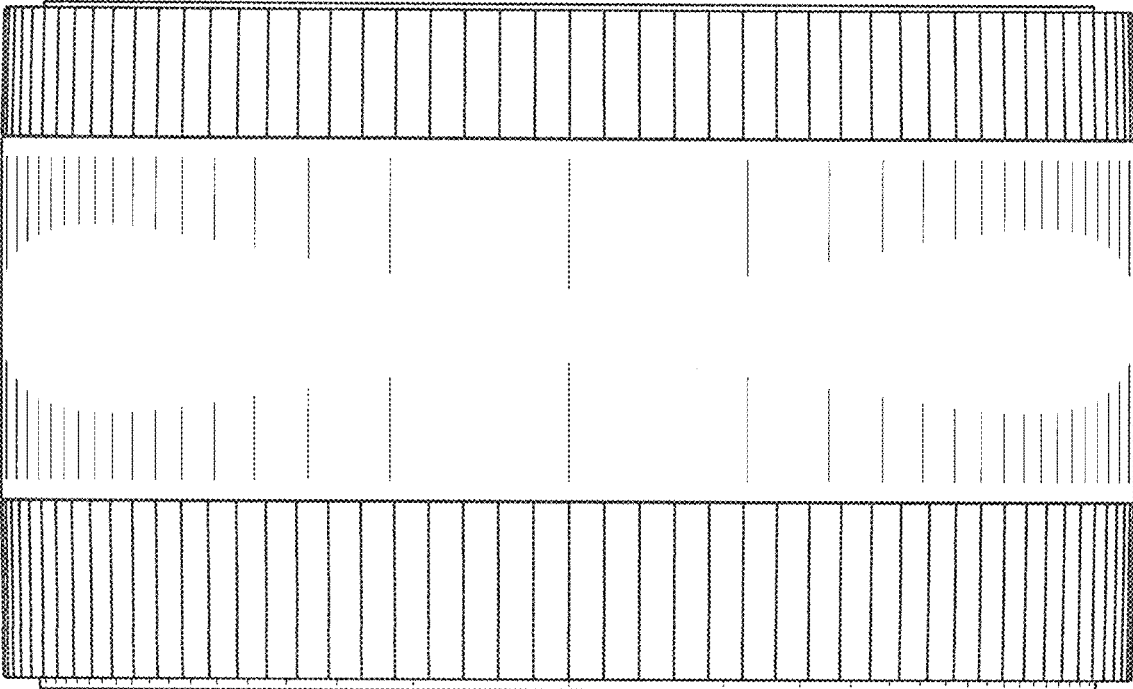

FIG. 4

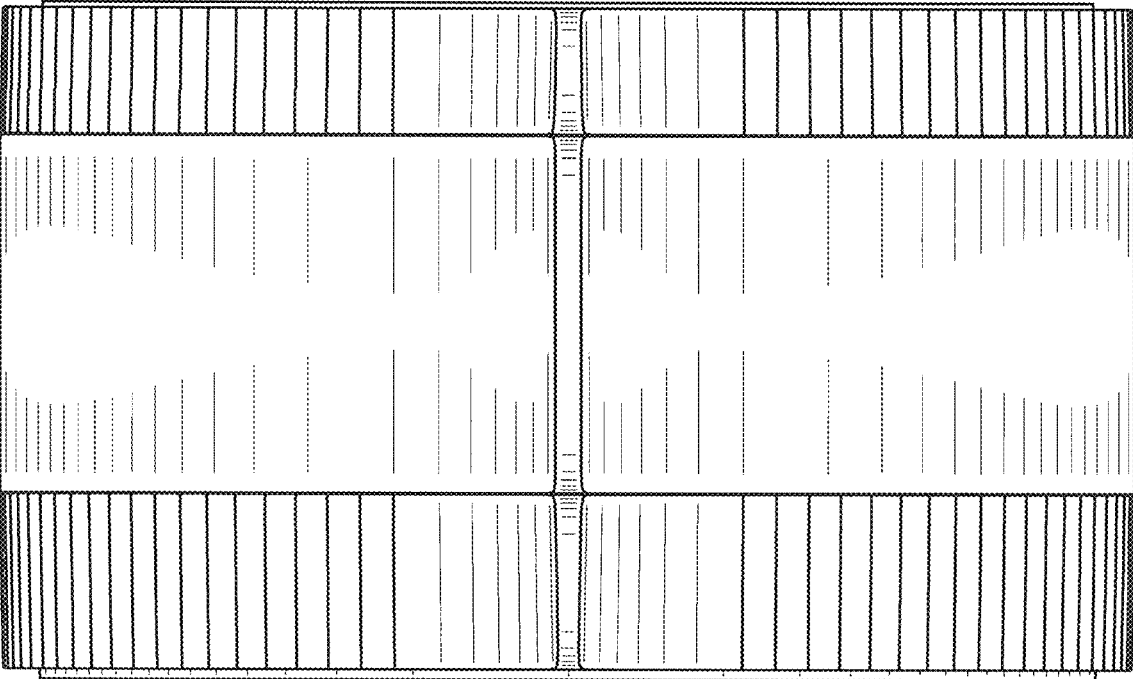

FIG. 5

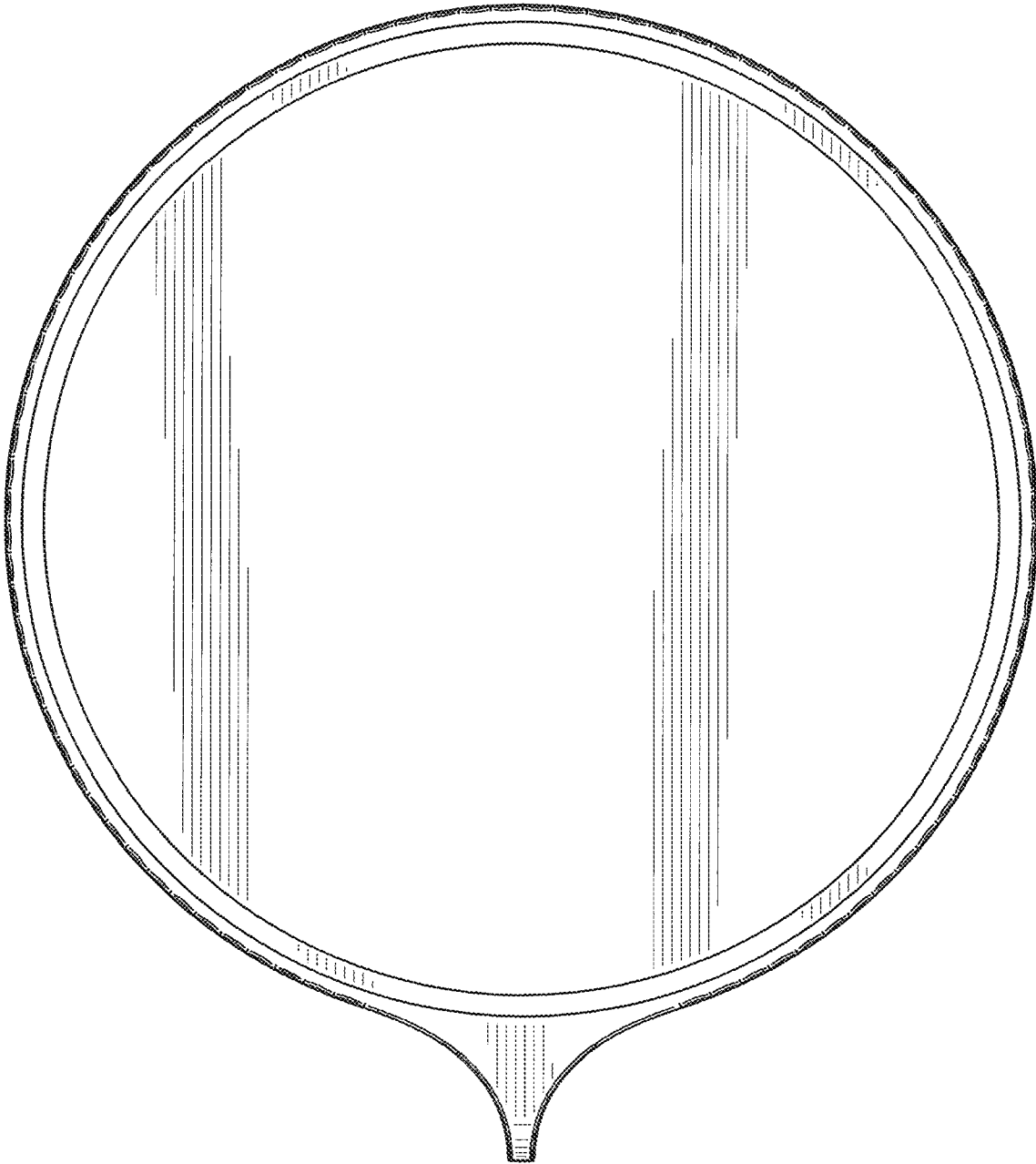

FIG. 6

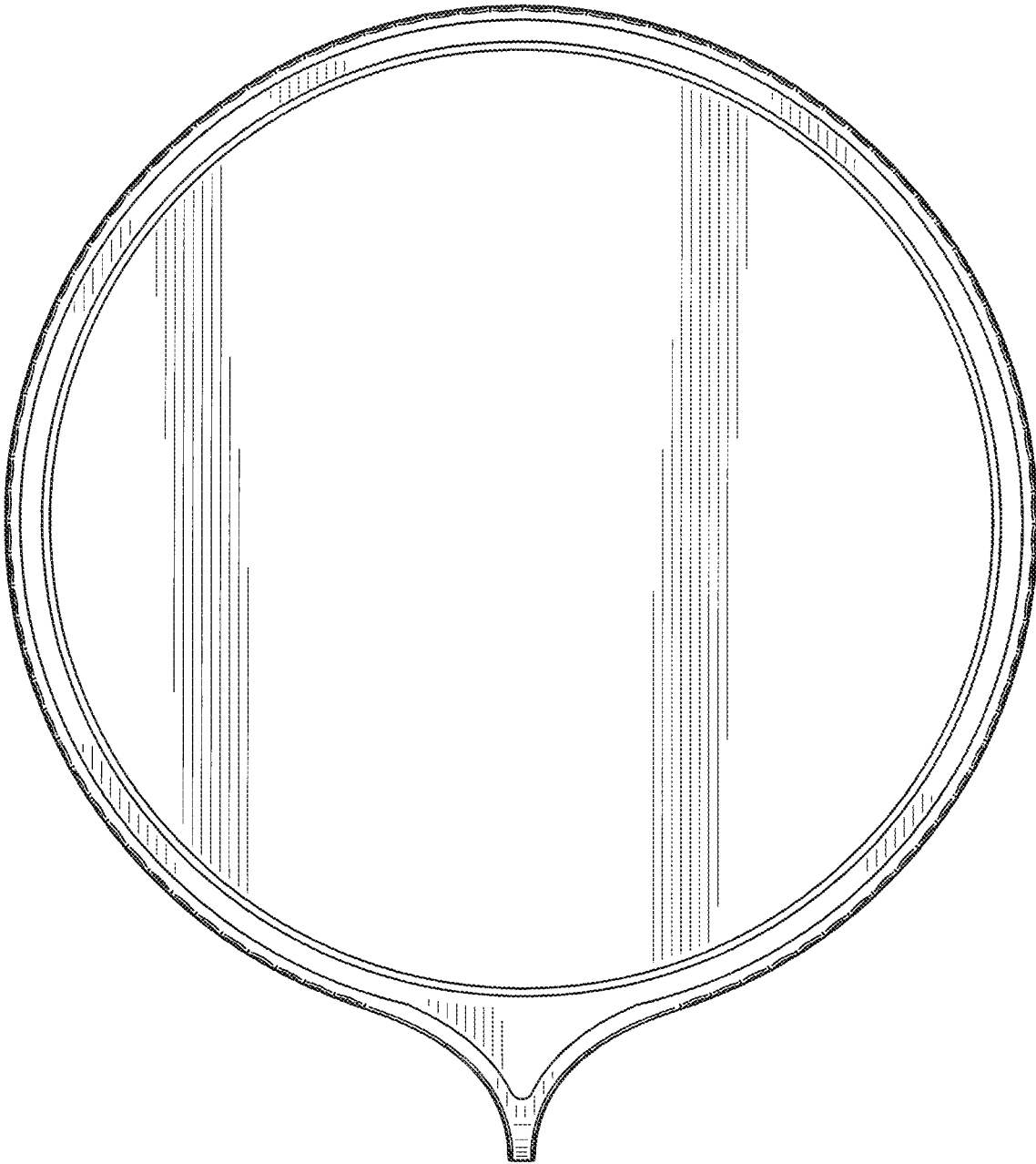

FIG. 7

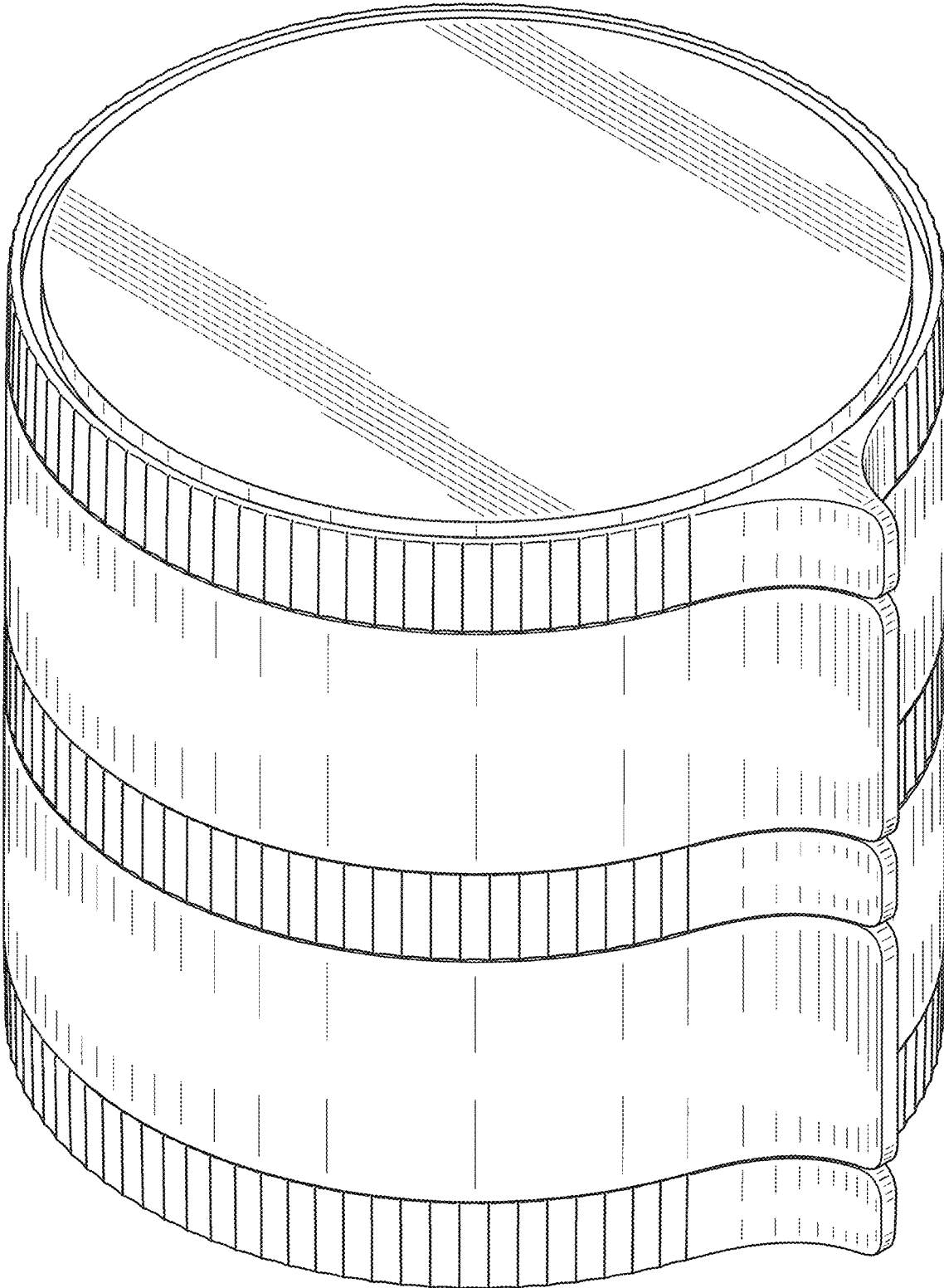

FIG. 8



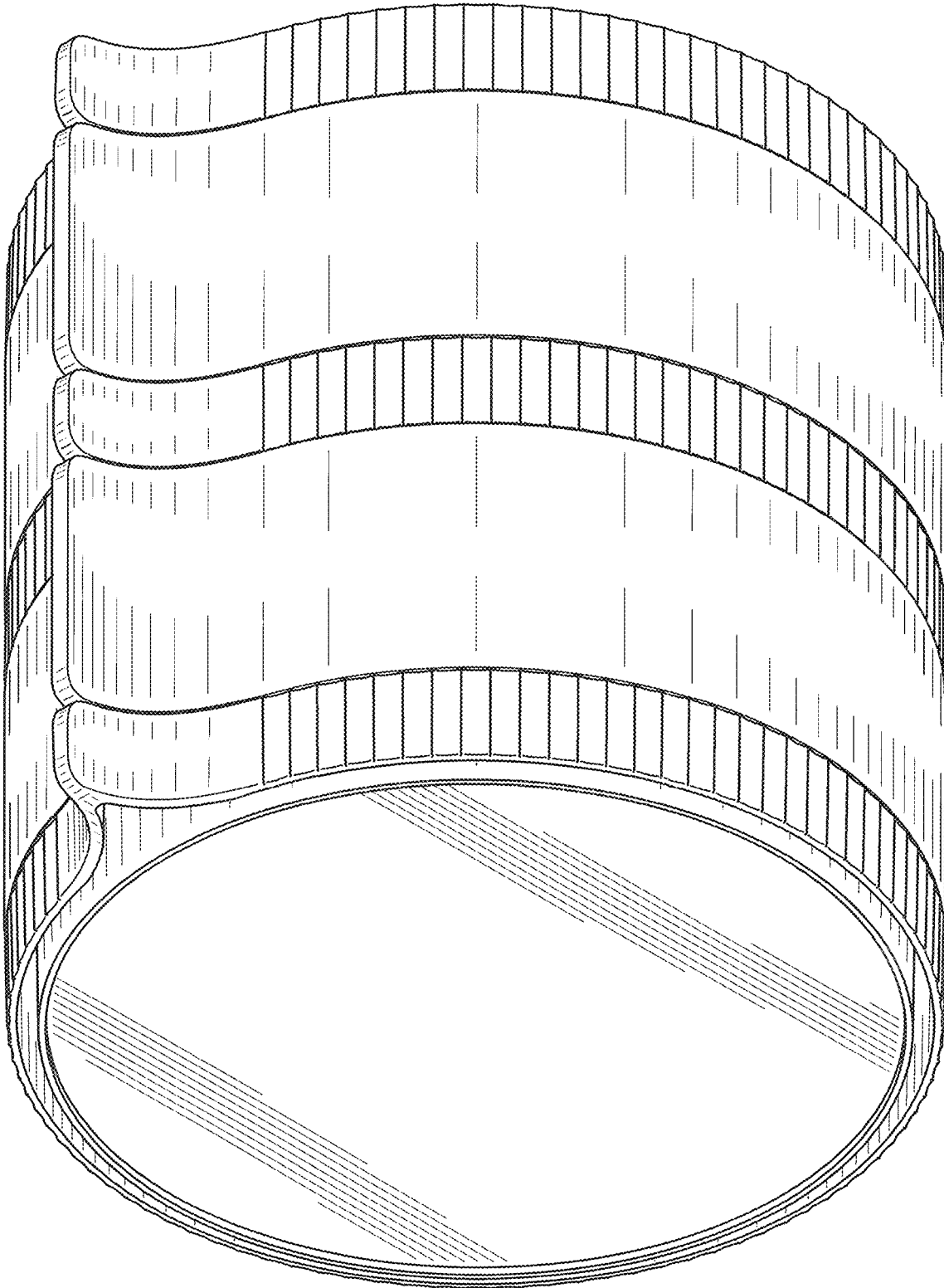

FIG. 9

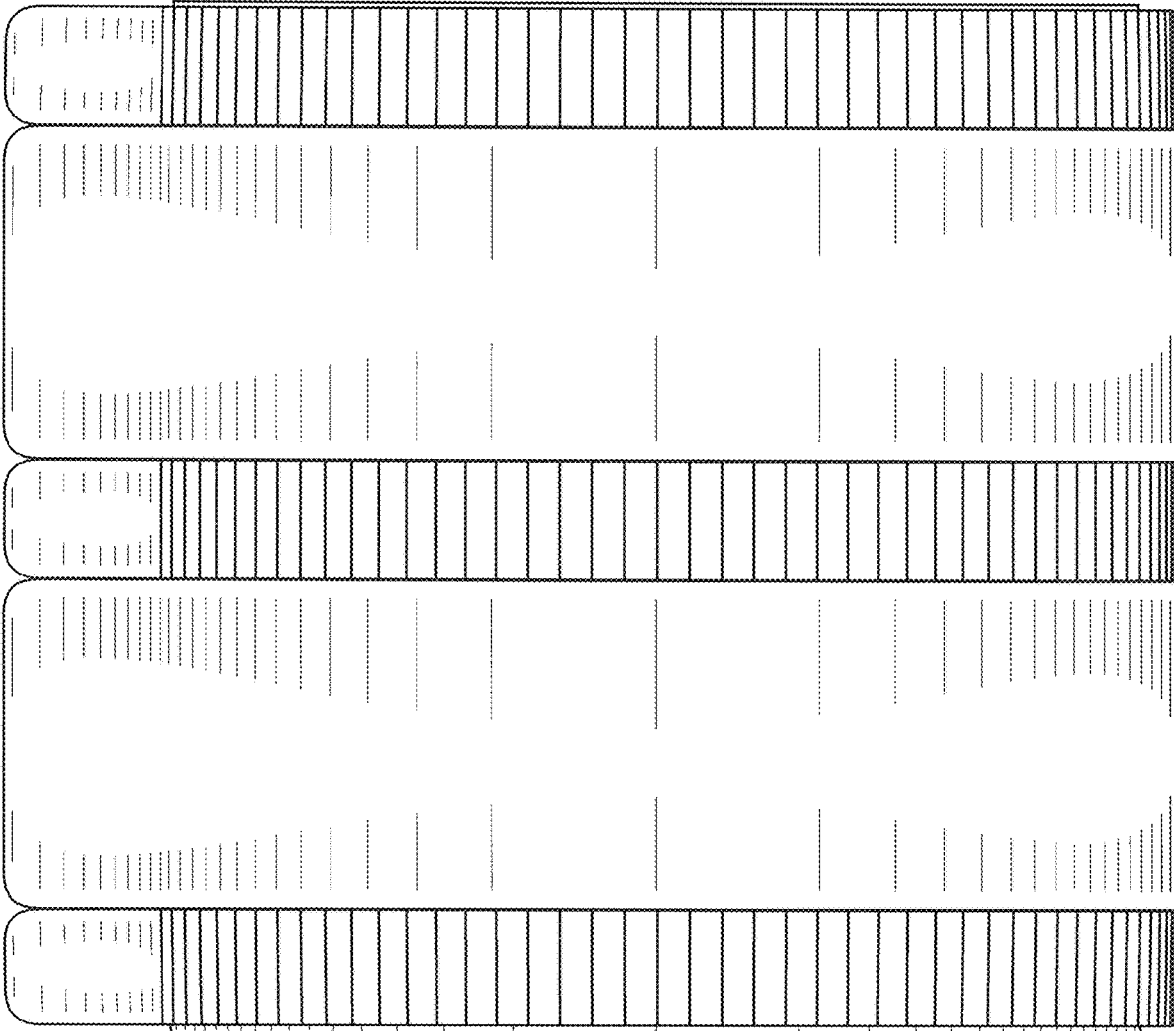

FIG. 10

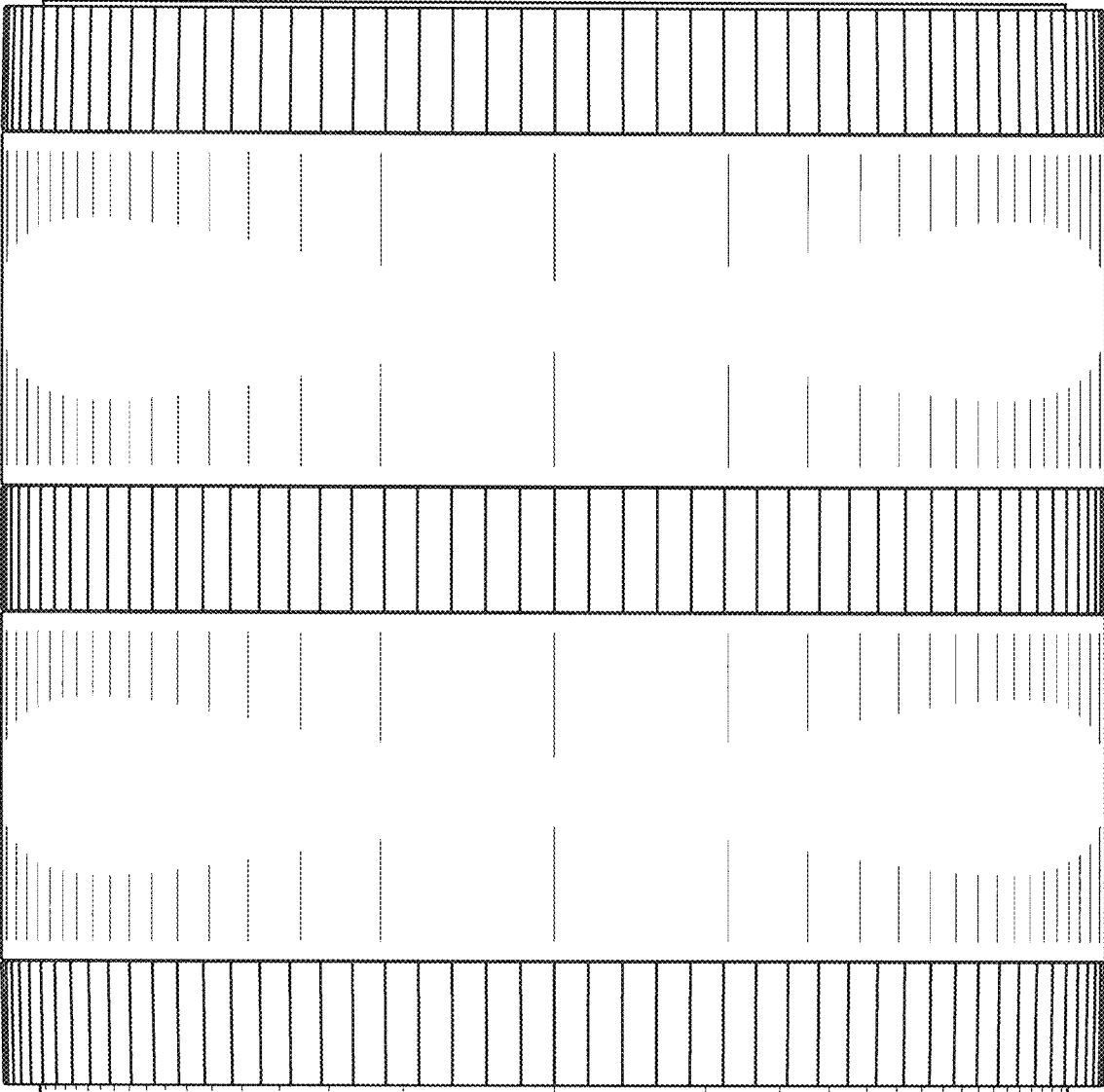

FIG. 11

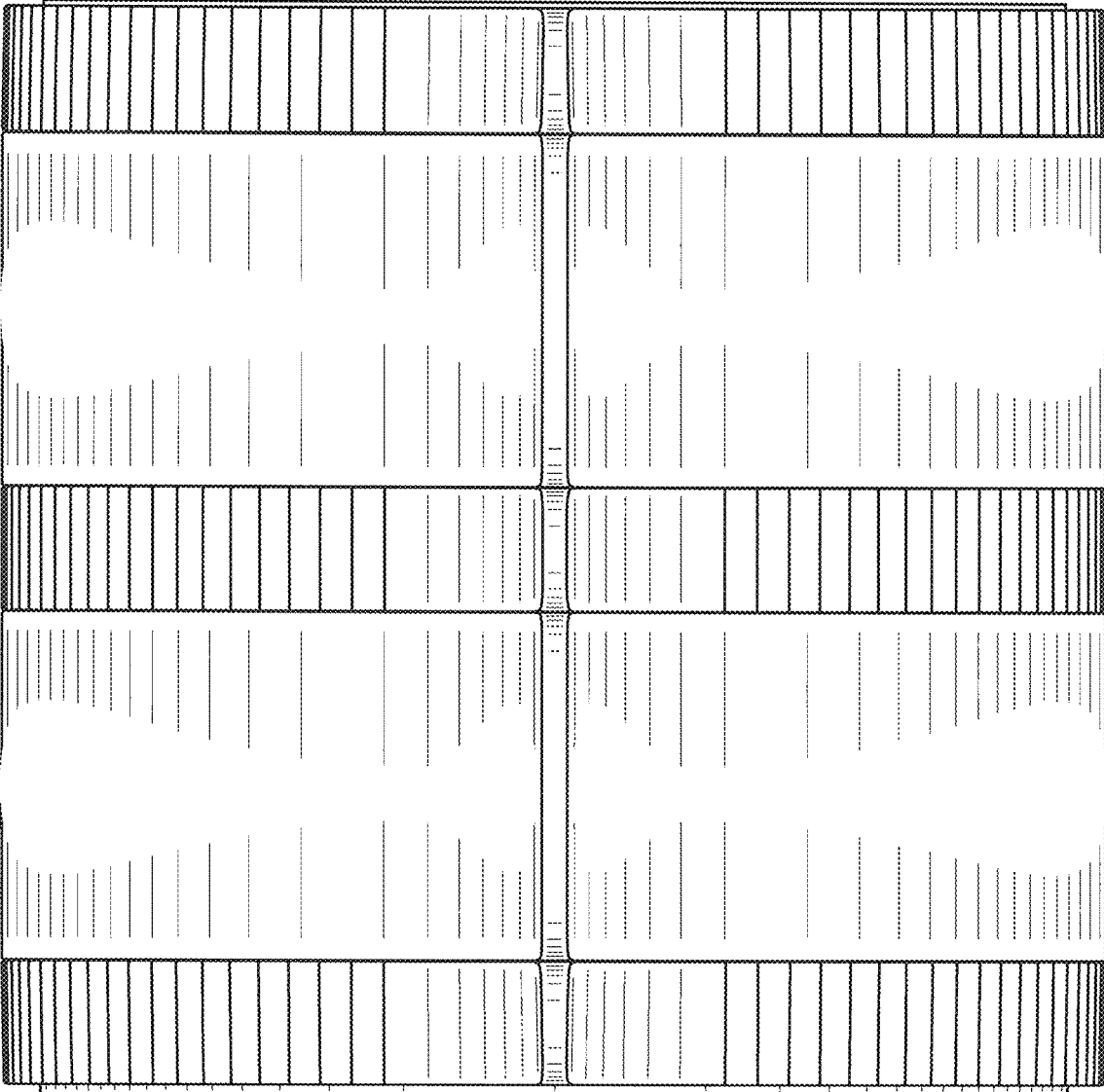

FIG. 12

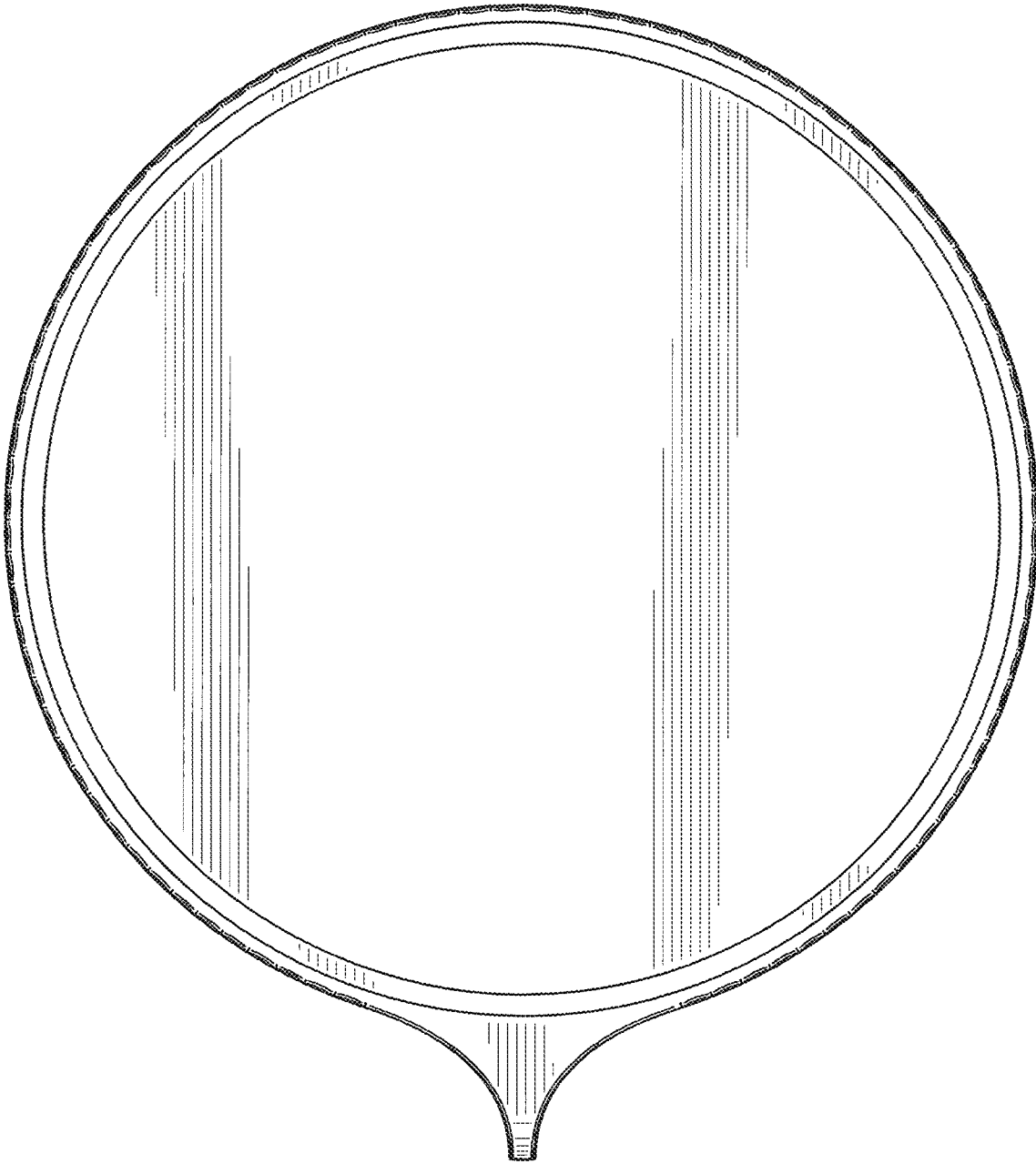

FIG. 13

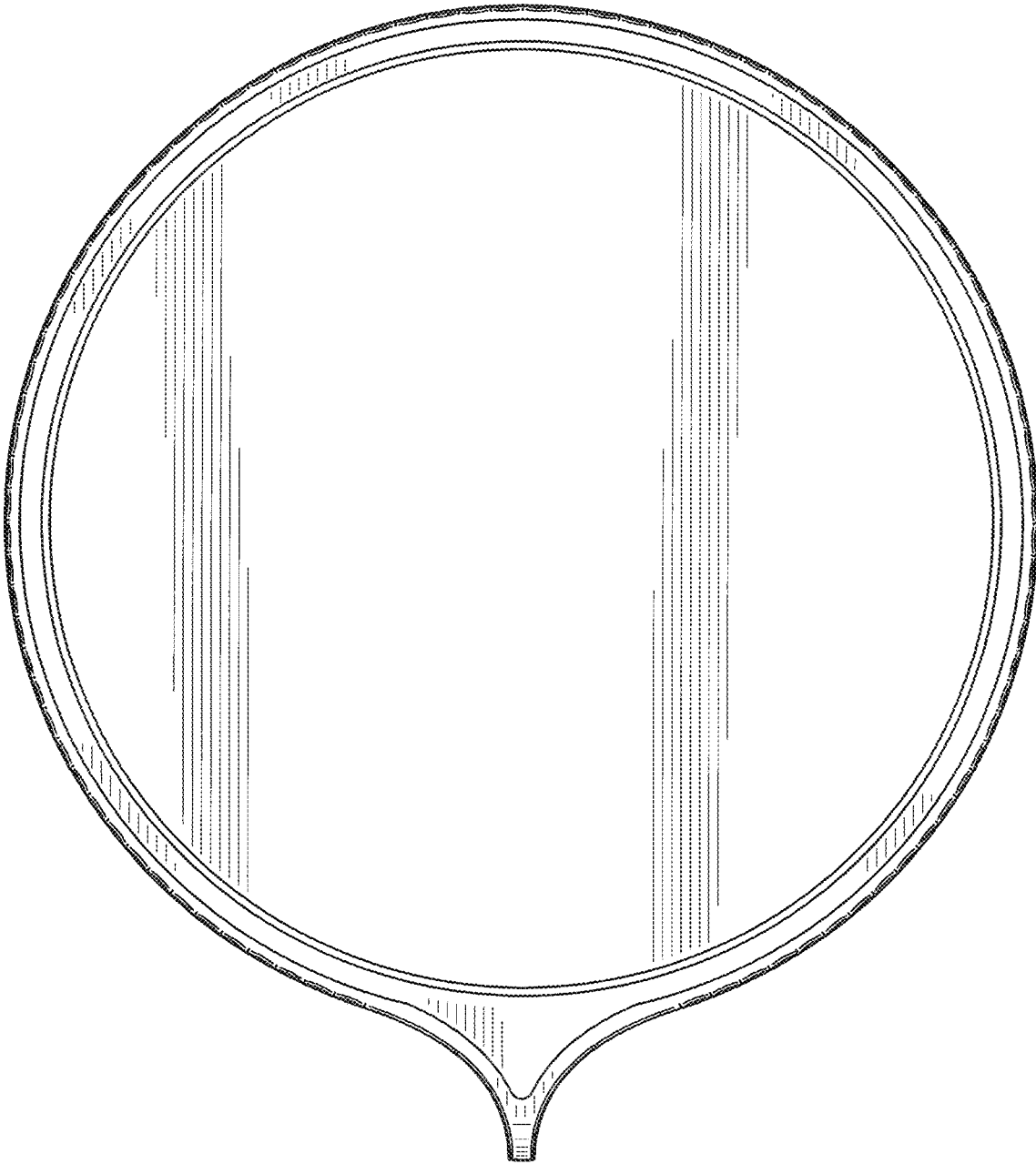

FIG. 14